

LaserLathe®

Cylindrical Micromachining

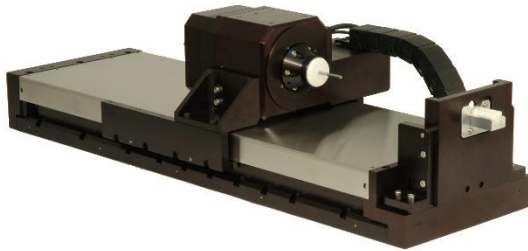

LaserLathe provides a ready-to-operate solution for high-throughput precision positioning and indexing of small diameter tubular and cylindrical components. LaserLathe systems are application specific platforms which integrate various components including linear and rotary motion, a variety of work piece holding devices, powerful servo drives and a user-friendly, feature packed Graphic User Interface, the nuFace GUI, and a digital servo control system.

Precise Positioning

A dedicated 2-axis mechanical motion platform integrates a linear X-axis and Θ (theta-axis) motion. Both axes utilize direct drive, brushless servomotors with integrated non-contacting, high-resolution encoders. The drive, guide and encoder systems in LaserLathe combine to provide smooth motion, and precise positioning necessary for laser operations on small diameter and high-precision tubular components. The mechanical motion platform is a sealed autonomous module designed for installation on any horizontal or vertical surface creating a horizontal motion axis. Complete protection against vapor, plasma, mist and processing debris and a Labyrinth seal for environmental protection is provided by stainless steel cover system with CLS.

- **High Precision Performance**
- **CNC controls & GIU with Digital Servo Technology**
- **Ultra-Precision Clamping Collets**
- **Exceptional Concentricity and High Coaxiality**
- **Excellent Serviceability**
- **Protective Sealed Motion Components**

Laser Control

Laser control with Intelligent **LPM** an innovative technique to implement Laser Power Modulation (LPM) as a function of position or vector velocity, realtime; sometimes referred to as PSO. Intelligent **LPM** permits laser power control and rep rate as a function of cutting speed directly and/or path directly from the MM9 I/O.

Tooling

The LaserLathe includes a set of tooling features with tapped mounting holes for attaching end-user guide system to control the work pieces at the user-defined laser processing point.

The use of a modular component attachment system permits end-user configured guide bushing systems, liquid flush and assist gas systems and other process hardware to be easily integrated with the LaserLathe.

Digital Servo Control

NUTEC's Laser Lathe is equipped with the MICROMATIC-9, an all-digital Delta Tau DSP based high-performance servo and machine automation controller. The system includes full function process control, featuring laser fixing synchronized with motion.

Front Guide System

The standard LaserLathe FGS includes an axially adjustable bushing for various outside diameters bushings. Various sizes range from 6 mm to 16 mm. Behind the bushing holder is a pneumatic workpiece gripper which facilitates an automated reload cycle of fresh tubing length to be fed forward for a new cutting cycle.

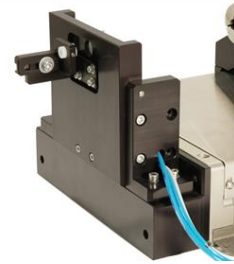

High Precision Front Guide System

The High Precision LaserLathe FGS includes axially adjustable bushing with precision guides for outside diameters of 8 – 16 mm.



V-Guide Front Guide System

The V-Guide LaserLathe FGS eliminates the need for matching bushing diameter. The V-Guide facilitates the change to different work piece diameters ranging from 0.5 – 5 mm. The optional down hold contains the work piece for optimal concentricity and wobble.



3-Jaw Chuck

Pneumatically operated open-close 3-jaw precision chuck. The chuck has a work piece diameter range from 1 – 8 mm. The chucks are designed for low TIR of 15 micron max. Offers interchangeable jaws with precision locator boss to replicate concentricity.

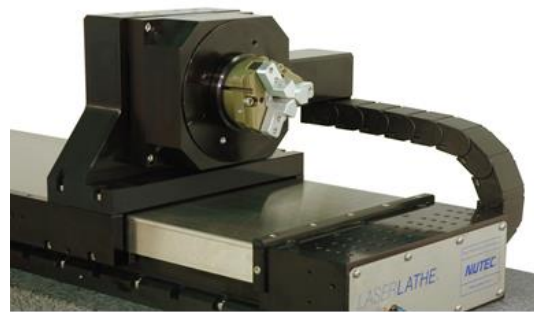

Moving Rear Guide Support

Completely adjustable in Y-Z and X (longitudinal) for all diameters. To support long length tubes during the cutting process.

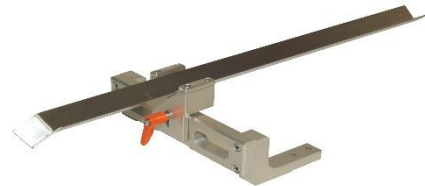

Workholding Collets

Clamping the workpiece stock is automatic and requires no operator intervention. High precision adjustments allow the LaserLathe to tailor the applied clamping force, and to control the range of collet closure & opening to match the work piece. This in conjunction with a large selection of standard Metric and Inch size collet diameters facilitates the working of most any material, form factor, size and length. Tube stock is securely clamped in the precision collet assuring very low run-out and wobble during processing.



Dynamic Path Accuracy

Digital Servo Controls with Intelligent Path control capabilities for creating true circles, arcs and contours.

Set Program Warning, following error limits for maximum desired path error and adjust maximum velocity and/or acceleration for tight stent geometry.

Advanced Tune Program provides profiles for tune optimization. Advanced plotting and diagnosis tools display real time performance to help further minimize following error.

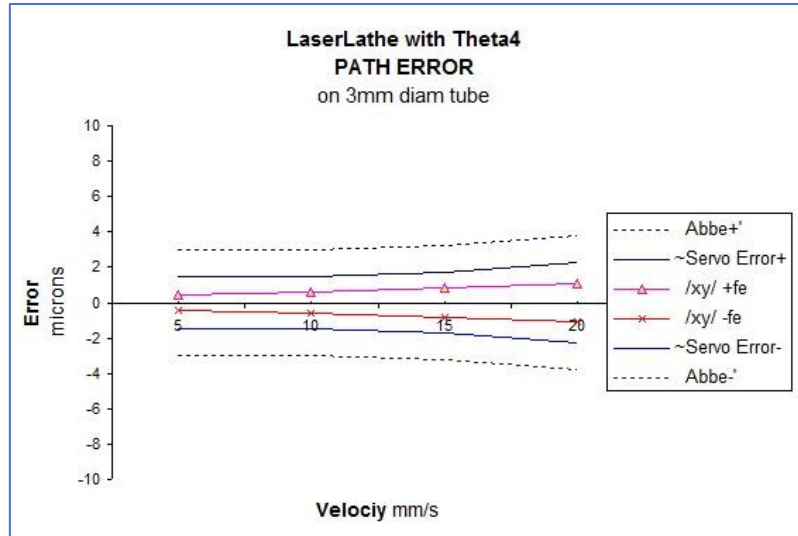

LaserLathe PCNC Hardware Package

PCNC Control System

The principal components of the hardware control system includes:

- MICROMATIC 9 Digital Servo Control
- Industrial PC with nuFace GUI installed
- LCD touchscreen 19" with soft keyboard
- All cables and wiring
- Optional Live Video System

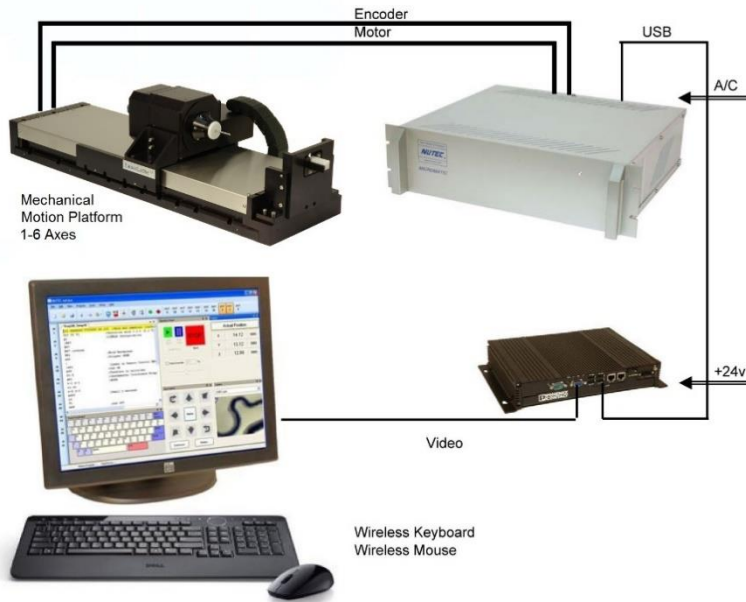

MICROMATIC-9: Digital servo control with extensive capabilities.

Industrial PC: Intel Atom D525 processor, 1.8 GHz, 4GB memory, Ethernet, USB, RS-232.

LCD 19" Touchscreen Monitor: ELO monitor with high picture quality.

LaserLathe Options

These are some of the available options:

- X travel 250, 375, 500 and 625mm
- Y-cross axis 25-100mm, screw driven or linear motor
- Vertical Z-Axis for beam delivery optics
- Moving Rear Guide System
- Granite Base with Granite Tower with interfaces for laser & optics
- Machined chassis 19" RM with Pendant for touch screen monitor, keyboard, Operator Panel with EMO push stop, 2 USB ports, Laser key switch, LED lights and laser bypass.
- Water System 90PSI
- Custom Front Guide System
- XHP super precision performance version
- Customized GUI
- CAGILA Postprocessor for CAD data transfer
- Machine System ready for laser & optics
- Femto laser versions

LaserLathe Accessories

Pneumatic Control Module:

Dual circuit for controlling collet and workholding. Open-Close and workpiece for auto reload. Includes DB-connector electronic interface.

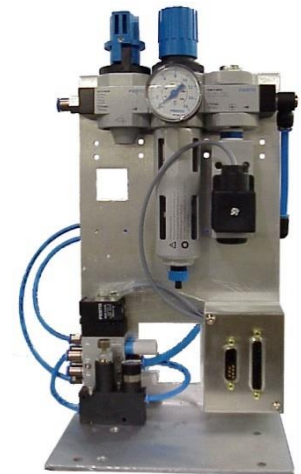

Cutter Box:

Available as short version 225 mm part length or long version 450 mm part length. Other lengths are optional (See factory for details) The design features an interlocked hinged outer section permitting the opening to gain access for tooling change. There is a part catcher tray with a perforated bottom for water drainage. A vacuum port allows evacuation of vapors. Waste water exits through large drain. Inside the cutter box is a tooling support feature for installing supports for delicate or long parts.

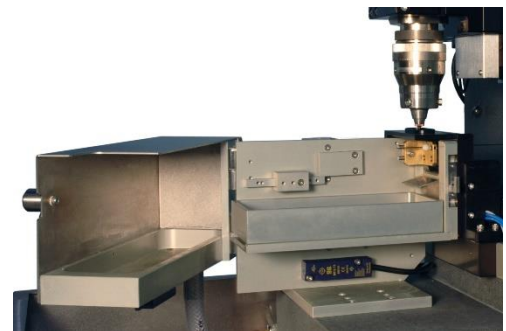

Water System:

A water system module delivers 90PSI supply of water. All components of the water system are contained in a box-style module including the pump, loud holding and pressure tanks, valves, filters, sensor, electrical control connections, electrical supply, tubing connections, drain filters,

An option is a refill system for automatic fresh water replenishment.



LaserLathe Specifications

	Linear Axis	Rotary Axis
Travel	250 / 375 / 500 / 625 mm	± 360° Continuous
Accuracy	3 μm ± 2.5 μm / 125 mm LIBEC* : ≤ 1 μm	≤ 25 arc second
Repeatability	± 1 μm	± 4 arc second
Straightness	± 1 μm / 100 mm	N/A
Flatness	± 1.5 μm / 100 mm	N/A
Yaw	≤ 15 arc second	N/A
Pitch	≤ 15 arc second	N/A
Maximum Speed	Max: 1000 mm/sec Cutting Speed: 40 mm/sec	Max: 100 rad/sec Cutting Speed: 15 rad/sec
Maximum Force (Continuous)	150 N	N/A
Maximum Torque (Continuous)	N/A	4.9 Nm
Resolution	50 nm	1.095 arc second
TIR Inside Collet Adaptor	N/A	≤ 2 μm
Rotational Inertia	N/A	0.001 kg·m ²
Collet System		
Actuation	Pneumatic	
Adjustable Closing Force @90 PSI	0 - 600 N [130 lb]	
Minimum Stock Size	0.2 mm	
Maximum Stock Size	32 mm	
Usable Collet Types	3C / 5C / D / W / F / E	
Air Supply recommendation	minimum 90 PSI / 6.2 bar	
Electrical Supply and Controller		
Supply Voltage	110 VAC - 10 AMP, Alt 22 VAC	
Digital Servo Control	MICROMATIC 9	
Programmable Axis	4- Axis; optional expansion to 6 axis	
Digital I/O, Standard	16 in / 8 out	
Digital I/O, Optional (expansion Board)	32 in / 16 out	
Analog I/O, Optional	2 in 16-bit / 2 out 12 bit	
Communication Interfaces	USB, Ethernet	
Programming Language	G-Code, RS-274, Custom MMI-GUI	

*LIBEC is Laser Interferometer Based Error Correction. LIBEC is available at time of order developed and configured with our MM9 control. LIBEC error mapping dramatically improves position accuracy.

LaserLathe Part Order Information

LL	-8999	-250	-R050	-PCNC	-FGS	-3C	-Q-MAX
Series	Model	Travel	Resolution	Control Package	Guiding System	Collet Option	Accessories
		-250 -375 -500 -625	-R050 -R0.1	-PCNC	-FGS -HPFGS -VGFGS -MRGS	-3C -5C -ER -W -F -3J-08	-XLED -Q-MAX -WS -FD -LIBEC -LEMO -CMS

LaserLathe Laser Cutting System

LL LaserLathe direct drive cylindrical laser machining system

Model

-8999 Latest generation of the LaserLathe

Travel

-250 250 mm (9.84 in) linear axis travel
 -375 375 mm (14.76 in) linear axis travel
 -500 500 mm (19.69 in) linear axis travel
 -625 625 mm (24.61 in) linear axis travel

Resolution

-R050 Encoder with a 50-nanometer resolution
 -R0.1 Encoder with a 100-nanometer resolution

Control Package

-PCNC Package includes industrial PC, 19" monitor, **nuFace™** GUI

Guiding System

-FGS Front Guiding System
 -HPFGS High precision Front Guiding System
 -VGFGS V-Guide Front Guide System
 -MRGS Moving Rear Guiding Support

Collet Option

-5C -3C -ER -W -F Collet option to fit correct tube diameter
 -3J-08 3-Jaw Chuck with tubing diameter size

Accessories

-Q-MAX Beam Delivery Cross Axis (Y axis) using reliable Q-MAX 25 mm travel stage
 -WS Water Supply kit and system
 -FD Z-Vertical Axis
 -LIBEC LIBEC error correction
 -LEMO Waterproof LEMO Connectors
 -CMS CMS pendant option with Monitor, Operator Panel and USB ports

LaserLathe Dimensions

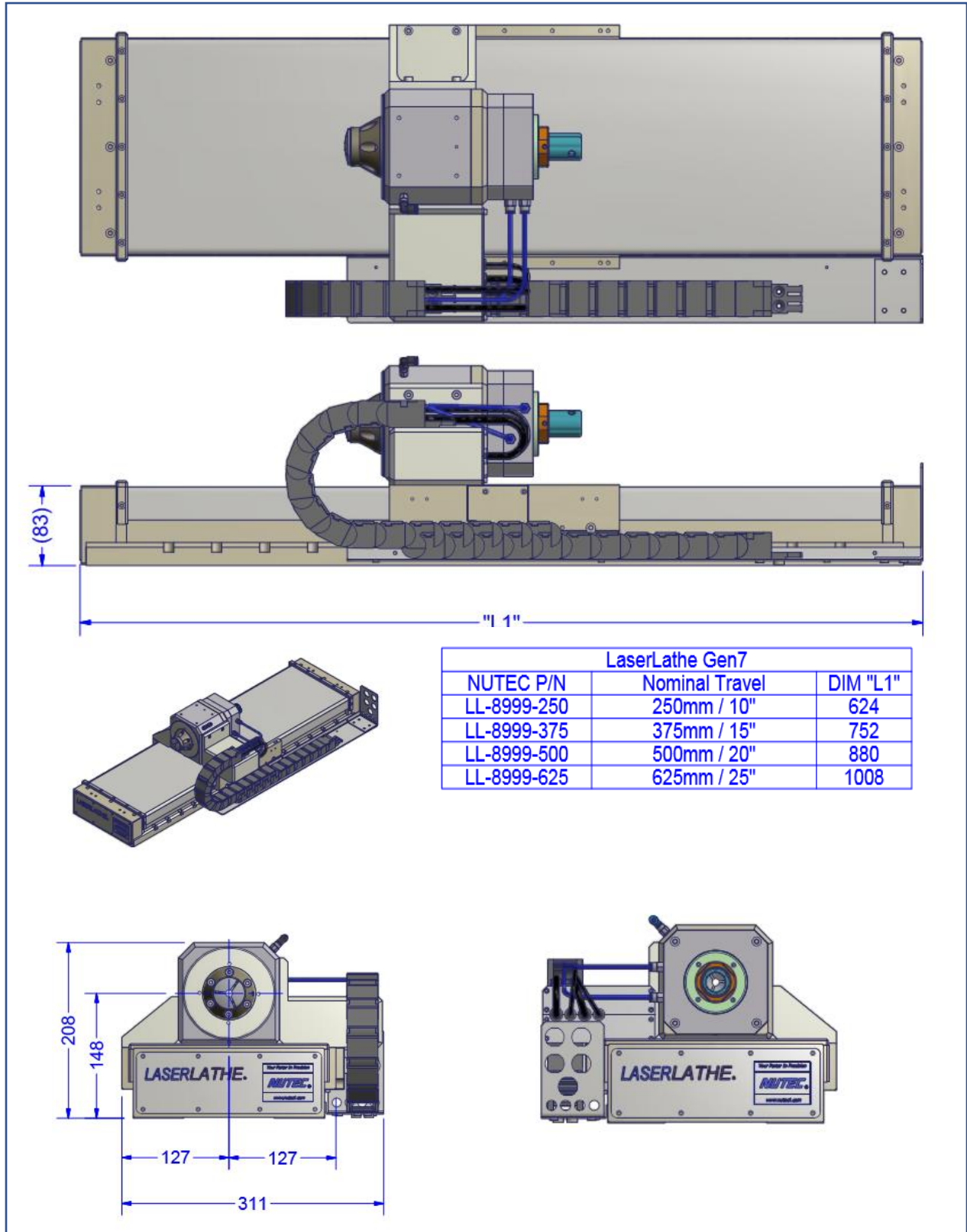

LaserLathe Dimensions

